

ISA100 Intrinsically Safe Wireless Pressure Sensor

IS-WPS Series

32317842

Issue 1

Datasheet



DESCRIPTION

Honeywell Wireless Intrinsically Safe Pressure Sensors, IS-WPS Series, is an ISA100.11a-compliant wireless device that integrates into new or pre-existing instrumentation systems. It has a variety of remote or built-in antenna options.

It features an aluminum alloy metal enclosure finished with blue/grey epoxy paint, corrosion-resistant construction, and is suitable for outdoor applications in harsh environments due to its IP65 and IP67 sealed enclosure. Its pressure port and pressure diaphragm are made with corrosion-resistant material making it resilient to harsh process media. The direct or remote-mount antenna options add flexibility for adaptation to various applications.

The IS-WPS Series is beneficial for remote pressure monitoring applications in hazardous areas where wiring or wire maintenance is physically challenging or impossible or economically infeasible. Combining this greater flexibility with packaging designed for harsh-duty can result in enhanced efficiency and ease in establishing remote, cost-effective process sensing.

VALUE TO CUSTOMERS

- **Hazardous location protection:** Intrinsically safe design allows for use in certified atmospheres containing flammable gases and vapors
- **Can save time and money:** Wireless operation and signal transmission minimizes the need to physically send maintenance engineers into the field
- **Reliable:** Consistent sensing option that meets the harsh environments

FEATURES

- Radio (license-free and global): WPAN 802.15.4, 2.4 GHz, ISA100.11a provides increased reliability, flexibility, and security in wireless transmission
- Configurable platform: Designed for global availability
- Provides a Total Error Band (TEB) of $\pm 2.0\%$ within the operating temperature range
- Measures gage or absolute pressure ranging from 0 psi to 500psi through 0 psi to 15,000psi
- Ability to reconfigure multiple IS-WPS series sensors allows users to easily add, subtract, or relocate the IS-WPS Series sensor
- Over-the-Air (OTA) provisioning
- Can reduce costs: Minimizes installation/maintenance costs because there are no wires, conduit, clips, junction boxes etc.
- IP65 and IP67 sealing
- Designed to support direct mount or using bracket assembly for easier installation
- Readily available batteries can be obtained from electrical supply houses and distributors

POTENTIAL APPLICATIONS

- Process monitoring of important pressures
- Gauge replacement
- Liquid level sensing (corrosive or non-corrosive)
- Leak detection (detection of pressure drop)
- Process pump failure monitoring
- Well head monitoring
- Irrigation water pressure monitoring
- Equipment health monitoring
- Tank level monitoring (water or corrosive liquids)

DIFFERENTIATION

- Capable to co-exist and operate seamlessly with other ISA100.11a-compliant devices

PORTFOLIO

The IS-WPS Series is part of Honeywell's wireless switches and sensors.

ISA100 Intrinsically Safe Wireless Pressure Sensor, IS-WPS Series

Table 1. Specifications

Characteristic	Parameter
Series name	IS-WPS Series
Product type	ISA100.11a Intrinsically Safe Wireless Pressure Sensor
Pressure ranges#	0 psi to 500 psi, 0 psi to 5000 psi, 0 psi to 10000 psi, 0 psi to 15000 psi (gage or absolute)
Housing material	Aluminum alloy, finished with blue/grey epoxy paint
Housing type	Metal, Intrinsically Safe, with process port connections
Operating frequency	2.4 GHz radio (ISM)
Wireless standard	RF Code B: ISA100.11a Compliant; IEEE 802.15.4, 2.4 GHz Global License Free Band
Communication agency approvals/certificates*	16 dBm: FCC 15.247, Industry Canada RSS 210 Issue 8, ACMA, C-Tick Mark Conformity 8 dBm: ETSI EN 300 328 V1.8.1 (CE Mark)
Antenna connection/type	RP-SMA jack for direct mount or remote antenna options; omni-directional antenna standard
Weight	1,75 kg ±100 g
Signal range	1000 ft** [305 m]** clear line of sight between sensor and receiver when using 2.0 dBi integral field sensor antenna
Battery type	3.6 Vdc Lithium Thionyl Chloride; D Size, Quantity: 2; Recommended manufacturers: XENO Energy (P/N XL-205F), Honeywell (P/N: WBT5)
Data rate	250 kbps
Provisioning method	Over-the-Air (OTA)
RF module transmit power	Country Code A: 16 dBm max.; Country Code B: 8 dBm max.
Receive sensitivity	-98 dBm
Radome material	Polybutylene Terephthalate (PBT), Color: Black
Pressure port material	Stainless Steel 316L or 15-5PH SS or Crucible A-286
Process connection	1/2 in NPT male and 1/4 in NPT female 3/4 in NPT male and 1/4 in NPT female 1/4 in NPT female, 9/16-18 UNF female
Diaphragm material	Hastelloy® C276 or 15-5PH SS or Crucible A-286
Housing/wetted parts	Aluminum alloy metal enclosure/ Hastelloy® C276 or 15-5PH SS or Crucible A-286 diaphragm
Intrinsically safe battery pack	Honeywell P/N: WBT8
Sealing	IP65, IP67 (self certified by Honeywell)
cULus listing	Class I, Div I, Groups A, B, C, D T4 Class I, Zone 1 AEx ia IIC T4 Ga Class I, Zone 1 Ex ia IIC T4 Ga Class I, Zone 0 AEx ia IIC T4 Ga Class I, Zone 0 Ex ia IIC T4 Ga Tambient -40° C to +70 C°
ATEX certification	Zone 1 Ex ia IIC T4 Ga; Zone 0 Ex ia IIC T4 Ga
IEC Ex certification	Zone 1 Ex ia IIC T4 Ga; Zone 0 Ex ia IIC T4 Ga
EMC	Applicable standards: EN 300 328, V1.8.1; EN 61326-1 (2006); EN 301 489-1, EN301 489-17, V2.1.1
Shock	40 g per IEC 60068-2-27
Vibration	5 Hz to 200 Hz, 4 g, Sinusoidal per IEC 60068-2-6
Operating temperature	-40 °C to 70 °C [-40 °F to 158 °F]
Operating humidity	0 %RH to 100 %RH
Total Error Band (TEB)	±2 %FSS for ≥ 50 psi
Sensor output resolution	0.04 %FS
Periodic update interval	Field programmable rate: 1, 5, 30, or 60 second intervals
Battery life (P2P protocol)	6 years at 60 sec interval, 5 years at 5 sec interval, 2 years at 1 sec interval (At 25 °C [77 °F])
Battery location	Intrinsically safe battery pack inside base unit
Output	Digital output via wireless, end user configurable as psi, bar, kPa and Pa, local LCD variant also available
Measurement accuracy	Better than ±2.0 % Total Error Band (TEB), full scale, full temperature range. Example 100 psi is ±2 psi
Media isolated	Yes
Overload safe pressure	4X FS for 500 psi; 15,000 psi for 5K psi; 1.5X for ≥10,000 psi
Burst pressure	3000 psi for < 1000 psi; 15000 psi for 5000 psi; 26000 psi for 10,000 psi; 40000 psi for 15,000 psi

* Honeywell is continuing to add new Country Communication Agency Approvals as opportunities and requirements are established.

**Actual range will vary depending upon antennas, cables, and site topography.

Pressure ranges >1000 psi support only gage variant.

ISA100 Intrinsically Safe Wireless Pressure Sensor, IS-WPS Series

Table 2. Battery Pack Specifications

Characteristic	Parameter
Intrinsically Safe Battery Pack part number	WBT8
Non IS Honeywell part number	WBT5 (two batteries included)
Battery size	Size D (ER32L615)
Battery type	Lithium Thionyl Chloride
Nominal capacity @ 4 mA, up to 2 V	19 Ah
Nominal voltage	3.6 V
Max. recommended continuous current	230 mA
Max. recommended pulse current	500 mA
Weight	97 g [3.4 oz] max.
Operating temperature	-55 °C to 85 °C [-67 °F to 185 °F]
Storage temperature	30 °C
Suggested alternate sources of battery cell supply	Xeno Energy (part number XL-205F)

Note: For shipping purposes, two "D" sized Lithium Thionyl Chloride cells contain approximately 10 grams of lithium.

Figure 1. Limitless™ Wireless Pressure Sensor, IS-WPS Series, Connection Type 1 & 2 Dimensions

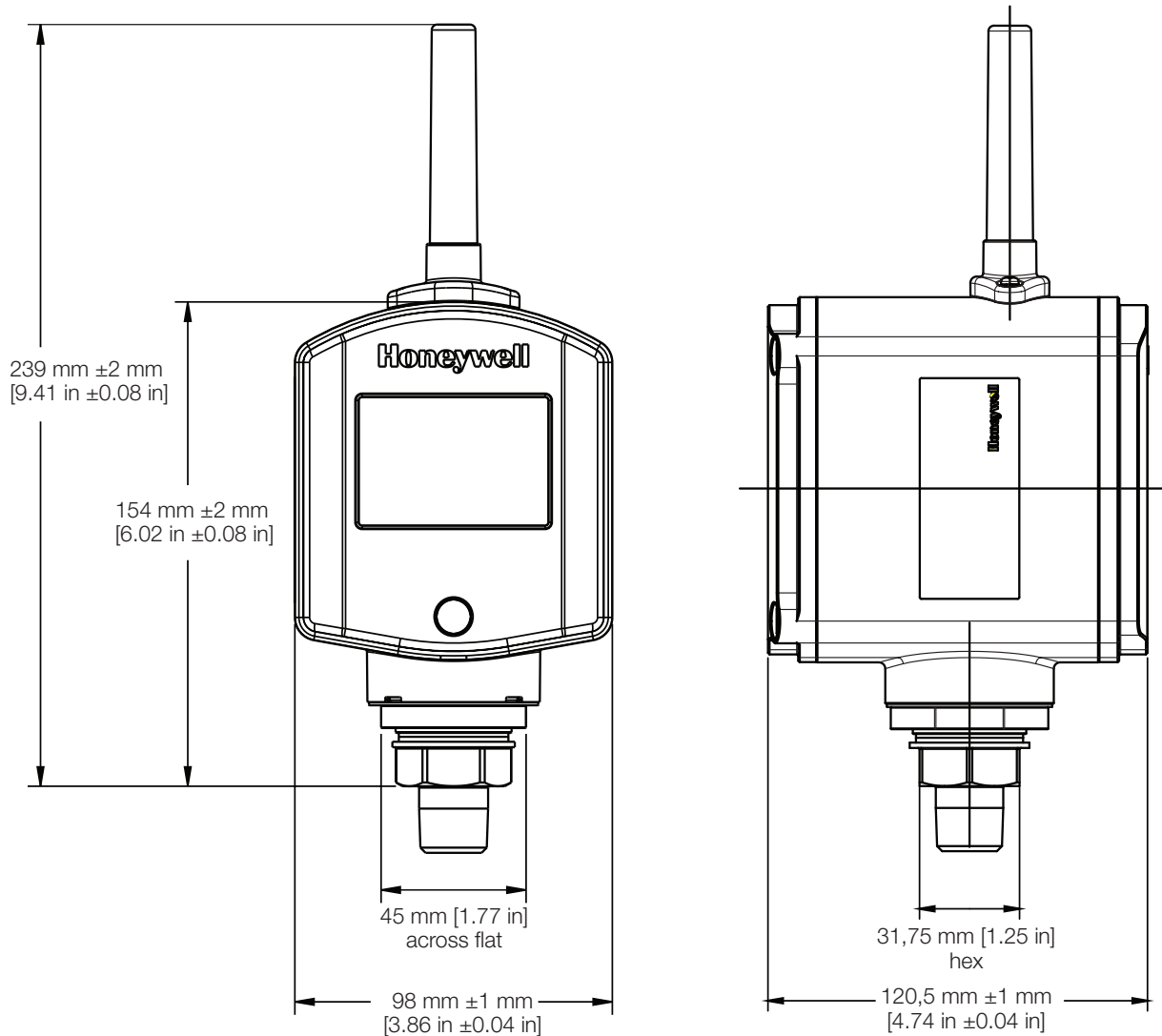

ISA100 Intrinsically Safe Wireless Pressure Sensor, IS-WPS Series

Figure 2. ISA100 Wireless Pressure Sensor, IS-WPS Series, Connection Type 3 & 4 Dimensions

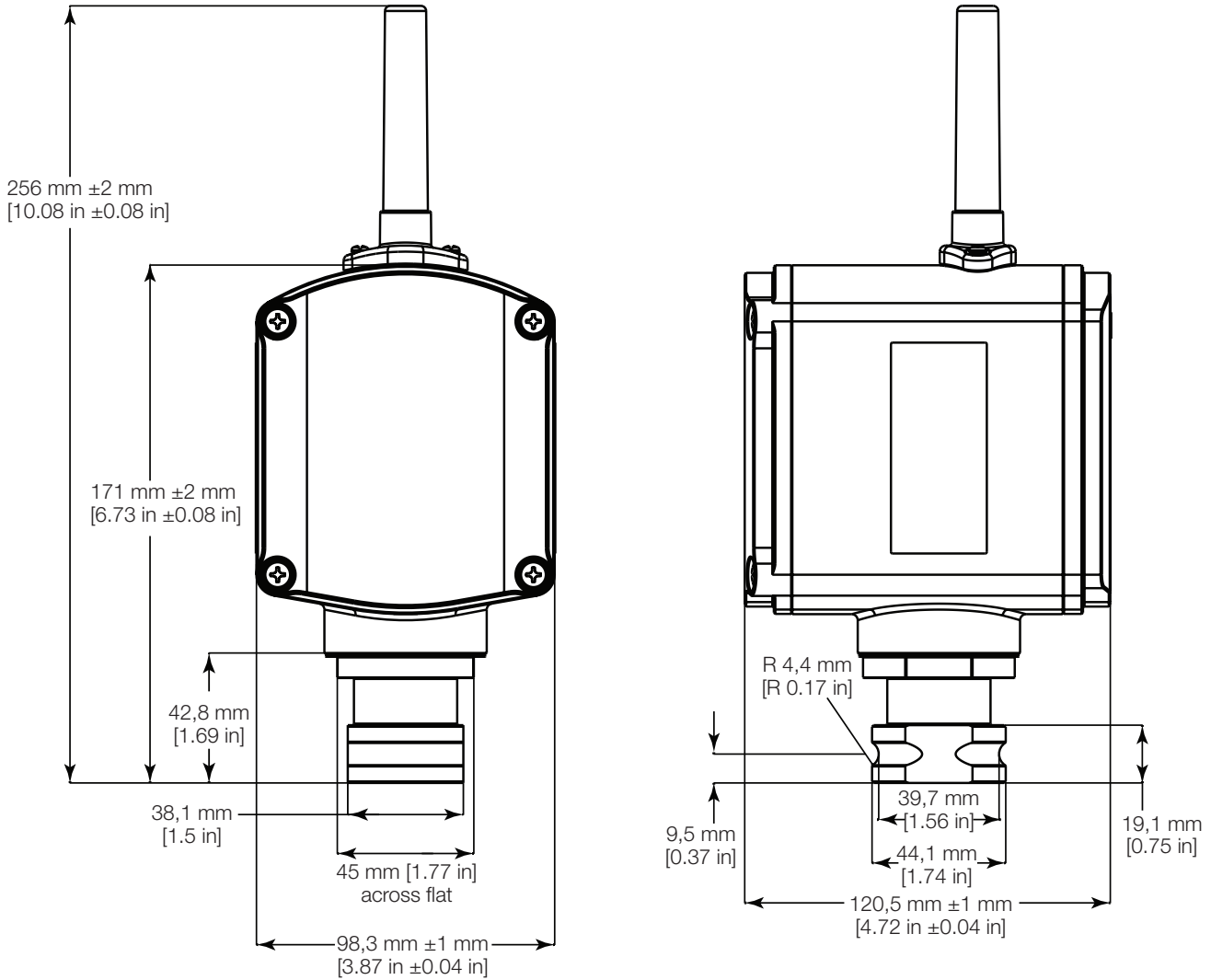

ISA100 Intrinsically Safe Wireless Pressure Sensor, IS-WPS Series

PRODUCT NOMENCLATURE

Figure 3. ISA100 IS-WPS Product Nomenclature

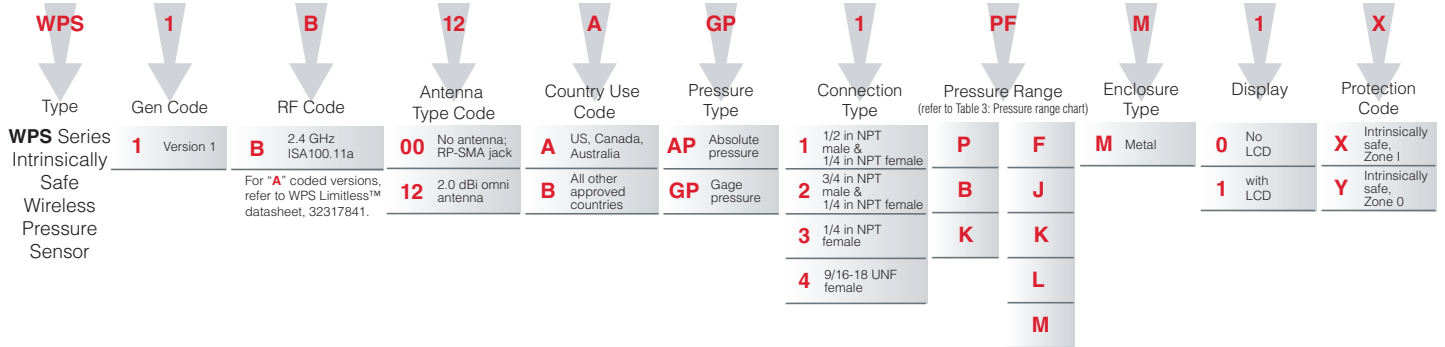

Table 3. Pressure Range Conversion Chart

		Pressure Range				
Port Material		316L SST	316L SST	15-5 PH SST	15-5 PH SST	Crucible A-286
Diaphragm Material		Hastelloy®	Hastelloy®	15-5 PH SST	15-5 PH SST	Crucible A-286
Unit Code	Description	F	J	K	L	M
P	psi	0 to 500	0 to 5000	0 to 10000	0 to 15000	0 to 15000
B	bar	0 to 34.5	0 to 344.7	0 to 689.5	0 to 1034.2	0 to 1034.2
K	kPa	0 to 3447.4	0 to 34473	0 to 68947	0 to 103421 ^A	0 to 103421 ^A









^AValues >99999 kPa will be displayed in MPa on LCD screen

ISA100 Intrinsically Safe Wireless Pressure Sensor, IS-WPS Series

Table 4. Antenna Options For Use with '00' Antenna Type Code









Antennas can be ordered with the IS-WPS Series Sensors by inserting the **Antenna Type Code** into the part number as shown in the nomenclature. Also, switches can be ordered without antennas, by using the "00" Antenna Type Code in the part number. Antennas may also be ordered separately using the **Part Numbers** below.

Table 4. Antenna Options: Country Code A

Ant. type code		Part number	Replacement antenna mount or cable	Antenna design	Ant. gain (max.)	Connector/mounting	Dimensions	Antenna material	Cable material/type	Mount material
00		WAN03RSP	-	flat	3.0 dBi	RP-SMA plug/adhesive mount	115 mm L x 22,1 mm W x 4,57 mm D [4.53 in L x 0.87 in W x 0.18 in D] 3 m [9.8 ft] cable	UV stable ABS	UV stable PVC/RG-174 coax	-
00		WAN04RSP	WAMM100RSP-005 base with 1,52 m [5 ft] of cable	tilt/swivel	5.5 dBi	RP-SMA plug/direct mount	Ø 12,7 mm x 208,28 mm L [Ø 0.50 in x 8.20 in L]	UV stable molded polyurethane	UV stable PVC/RG-174 coax	UV stable black ABS
00		WAN04RSP	WAMM100RSP-010 base with 3,05 m [10 ft] of cable	tilt/swivel	5.5 dBi	RP-SMA plug/direct mount	Ø 12,7 mm x 208,28 mm L [Ø 0.50 in x 8.20 in L]	UV stable molded polyurethane	UV stable PVC/RG-174 coax	UV stable black ABS
00		WAN05RSP	WAMM100RSP-005 base with 1,52 m [5 ft] of cable	tilt/swivel	9.0 dBi	RP-SMA plug/direct mount	Ø 12,7 mm x 384,05 mm L [Ø 0.50 in x 15.12 in L]	UV stable molded polyurethane	UV stable PVC/RG-174 coax	UV stable black ABS
00		WAN05RSP	WAMM100RSP-010 base with 3,05 m [10 ft] of cable	tilt/swivel	9.0 dBi	RP-SMA plug/direct mount	Ø 12,7 mm x 384,05 mm L [Ø 0.50 in x 15.12 in L]	UV stable molded polyurethane	UV stable PVC/RG-174 coax	UV stable black ABS
00		WAN-06RNJ	WCA200RN-PRSP-002 coax cable assembly 0,682 m [2 ft]	straight	8.0 dBi	RP-N jack/bracket	Ø 33,5 mm x 427,9 mm L [Ø 1.32 in x 16.85 in L]	UV stable fiberglass	UV stable PVC/RG-316 coax, UV stable Polyethylene/200 Series coax	300 series SST aluminum alloy
00		WAN-06RNJ	WCA200RN-PRSP-010 coax cable assembly 3,05 m [10 ft]	straight	8.0 dBi	RP-N jack/bracket	Ø 33,5 mm x 427,9 mm L [Ø 1.32 in x 16.85 in L]	UV stable fiberglass	UV stable PVC/RG-316 coax, UV stable Polyethylene/200 Series coax	300 series SST aluminum alloy
00		WAN08RSP	-	90°	0 dBi	RP-SMA plug/direct mount	Ø 8,0 mm x 29 mm L [Ø 0.34 in x 1.14 in L]	UV stable	-	-
00		WAN09RSP	-	low profile mobile	3.0 dBi	RP-SMA plug/magnetic	Ø 76,2 mm x 115 mm L [Ø 3.0 in x 4.54 in L] 4,57 m [15 ft] cable	UV stable ABS plastic	UV stable black PVC	Nickel-plated steel
00		WAN10RSP	-	straight	5.0 dBi	RP-SMA plug/magnetic	Ø 76,2 mm x 230,1 mm L [Ø 3.0 in x 9.06 in L] 4,57 m [15 ft] cable	Nickel-plated steel	UV stable black PVC	Nickel-plated steel
00		WAN11RSP	-	low profile mobile	4.0 dBi	RP-SMA plug/thru-hole screw	Ø 39 mm x 42,4 mm L [Ø 1.54 in x 1.67 in L]	UV stable black PVC	UV stable black PVC	Nickel-plated steel
12		WAN12RSP	-	straight	2.0 dBi	RP-SMA plug/direct mount	Ø 10 mm x 79,5 mm L [Ø 0.39 in. x 3.13 in. L]	UV stable ABS plastic	-	-

ISA100 Intrinsically Safe Wireless Pressure Sensor, IS-WPS Series

Table 5. Antenna Options - Country Code B

Ant. type code		Part number	Replacement antenna mount or cable	Antenna design	Ant. gain (max.)	Connector/mounting	Dimensions	Antenna material	Cable material/type	Mount material
00		WAN03RSP	-	flat	3.0 dBi	RP-SMA plug/adhesive mount	115 mm L x 22,1 mm W x 4,57 mm D [4.53 in L x 0.87 in W x 0.18 in D] 3 m [9.8 ft] cable	UV stable ABS	UV stable PVC/RG-174 coax	-
00		WAN04RSP	WAMM100RSP-005 base with 1,52 m [5 ft] of cable	tilt/swivel	5.5 dBi	RP-SMA plug/direct mount	Ø 12,7 mm x 208,28 mm L [Ø 0.50 in x 8.20 in L]	UV stable molded polyurethane	UV stable PVC/RG-174 coax	UV stable black ABS
00		WAN04RSP	WAMM100RSP-010 base with 3,05 m [10 ft] of cable	tilt/swivel	5.5 dBi	RP-SMA plug/direct mount	Ø 12,7 mm x 208,28 mm L [Ø 0.50 in x 8.20 in L]	UV stable molded polyurethane	UV stable PVC/RG-174 coax	UV stable black ABS
00		WAN08RSP	-	90°	0 dBi	RP-SMA plug/direct mount	Ø 8,0 mm x 29 mm L [Ø 0.34 in x 1.14 in L]	UV stable	-	-
00		WAN09RSP	-	low profile mobile	3.0 dBi	RP-SMA plug/magnetic	Ø 76,2 mm x 115 mm L [Ø 3.0 in x 4.54 in L] 4,57 m [15 ft] cable	UV stable ABS plastic	UV stable black PVC	Nickel-plated steel
00		WAN10RSP	-	straight	5.0 dBi	RP-SMA plug/magnetic	Ø 76,2 mm x 230,1 mm L [Ø 3.0 in x 9.06 in L] 4,57 m [15 ft] cable	Nickel-plated steel	UV stable black PVC	Nickel-plated steel
00		WAN11RSP	-	low profile mobile	4.0 dBi	RP-SMA plug/thru-hole screw	Ø 39 mm x 42,4 mm L [Ø 1.54 in x 1.67 in L]	UV stable black PVC	UV stable black PVC	Nickel-plated steel
12		WAN12RSP	-	straight	2.0 dBi	RP-SMA plug/direct mount	Ø 10 mm x 79,5 mm L [Ø 0.39 in. x 3.13 in. L]	UV stable ABS plastic	-	-

ISA100 Intrinsically Safe Wireless Pressure Sensor, IS-WPS Series

ACCESSORIES

Table 6. Replacement Parts

	Part Number	Description
	WAN12RSP	2.4 GHz, 2.0 dBi RP-SMA WLAN antenna
	WAN22RAD	Replacement WPS radome

Table 7. Cable and Coax Accessories







	Part Number	Description
	WCA200RN-PRSP-002	Limitless™ Series wireless cable assembly with 200 Series cable, 2 ft length, reverse polarity N plug to reverse polarity SMA plug, use only with WAN06RNJ antenna
	WCA200RN-PRSP-010	Limitless™ Series wireless cable assembly with 200 Series cable, 10 ft length, reverse polarity N plug to reverse polarity SMA plug, use only with WAN06RNJ antenna
	WCA200RNJR-SP-002	Limitless™ Series wireless cable assembly with 200 Series cable, 2 ft length, reverse polarity SMA jack to reverse polarity SMA plug
	WCA200RNJR-SP-005	Limitless™ Series wireless cable assembly with 200 Series cable, 5 ft length, reverse polarity SMA jack to reverse polarity SMA plug
	WCA200RNJR-SP-010	Limitless™ Series wireless cable assembly with 200 Series cable, 10 ft length, reverse polarity SMA jack to reverse polarity SMA plug
	WCA200RNJR-SP-015	Limitless™ Series wireless cable assembly with 200 Series cable, 15 ft length, reverse polarity SMA jack to reverse polarity SMA plug
	WCA200RNJR-SP-020	Limitless™ Series wireless cable assembly with 200 Series cable, 20 ft length, reverse polarity SMA jack to reverse polarity SMA plug

Table 8. Base Accessories





	Part Number	Description
	WAMM100RSP-005	Magnetic antenna base with 1,52 m [5 ft] of cable
	WAMM100RSP-010	Magnetic antenna base with 3,05 m [10 ft] of cable

Table 9. Brackets

Photo	Catalog Listing	Description
	WPB2	Angle mounting bracket for IS-WPS Series wireless pressure sensor. May be mounted vertically or horizontally.
	WPB3	Straight mounting bracket for IS-WPS Series wireless pressure sensor.

ISA100 Intrinsically Safe Wireless Pressure Sensor, IS-WPS Series

Table 10. Order Guide

	Part Number	Description
	WPS1B12AGP1PFM1X	ISA100.11a WPS Intrinsically Safe Wireless Pressure Sensor; 2.4 GHz; 2.0 dBI Omni antenna; United States, Canada, Australia; Gage pressure; 1/2 in NPT male; 0 psi to 5000 psi; Metal; with LCD; Intrinsically Safe, Zone 1
	WPS1B12AGP1PJM1X	ISA100.11a WPS Intrinsically Safe Wireless Pressure Sensor; 2.4 GHz; 2.0 dBI Omni antenna; United States, Canada, Australia; Gage pressure; 1/2 in NPT male; 0 psi to 5000 psi; Metal; with LCD; Intrinsically Safe, Zone 1
	WPS1B12AGP3PKM1X	ISA100.11a WPS Intrinsically Safe Wireless Pressure Sensor; 2.4 GHz; 2.0 dBI Omni antenna; United States, Canada, Australia; Gage pressure; 1/4 in NPT female; 0 psi to 10000 psi; Metal; with LCD; Intrinsically Safe, Zone 1
	WPS1B12AGP4PLM1X	ISA100.11a WPS Intrinsically Safe Wireless Pressure Sensor; 2.4 GHz; 2.0 dBI Omni antenna; United States, Canada, Australia; Gage pressure; 9/16-20 UNF female (Autoclave); 0 psi to 15000 psi (15-5 PH); Metal; with LCD; Intrinsically Safe, Zone 1

ISA100 Intrinsically Safe Wireless Pressure Sensor, IS-WPS Series

PRESSURE SENSOR GLOSSARY OF TERMS

Absolute Pressure (a) – Pressure measured relative to a perfect vacuum (zero pressure) reference.

Absolute Pressure Sensor – Product whose output is proportional to the difference between applied pressure and a built-in fixed reference to vacuum (zero pressure). Typically the Minimum Operating Pressure (Pmin.) is set to absolute zero pressure (perfect vacuum).

Accuracy – The maximum deviation in output from a Best Fit Straight Line (BFSL) fitted to output measured over the Compensated Pressure Range at Reference Temperature. Includes all errors due to: Pressure Non-Linearity, Pressure Hysteresis and Non-Repeatability.

Best Fit Straight Line (BFSL) – The straight line fitted through a set of points which minimizes the sum of the square of the deviations of each of the points from the straight line ('least-squares' method). See also Pressure Non-Linearity.

Burst Pressure – The maximum pressure that may be applied to any port of the product without causing escape of pressure media. The product should not be expected to function after exposure to any pressure beyond the burst pressure. See also Overpressure.

Full Scale Span (FSS) – The algebraic difference between output signal measured at the upper and lower limits of the Operating Pressure Range. Also known as 'Span' or ambiguously as 'Full Scale Output'. (See Figure 4.)

Figure 4. Illustration of Key Pressure Sensor Terms Relative to Operating Pressure Range

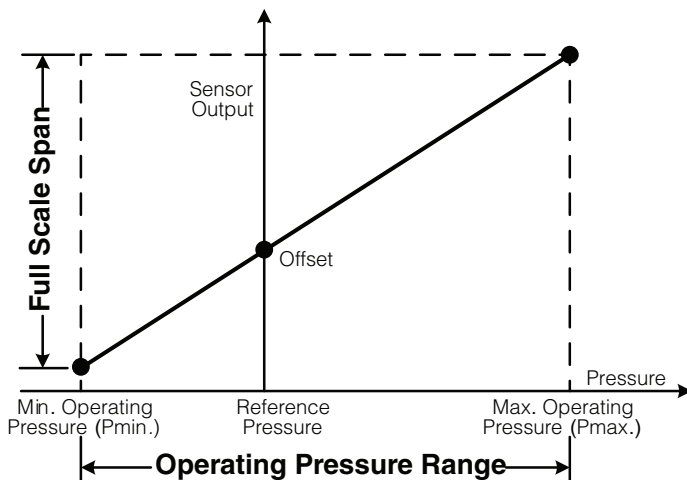

Gage Pressure (g) – Pressure measured relative to the local ambient (atmospheric/barometric) pressure. Also known as 'Gauge'.

Gage Pressure Sensor – Product whose output is proportional to difference between applied pressure and local ambient (atmospheric) pressure. Typically the Minimum Operating Pressure (Pmin.) is set to atmospheric pressure.

Maximum Operating Pressure (Pmax.) – The upper limit of the Operating Pressure Range. (See Figure 4.)

Minimum Operating Pressure (Pmin.) – The lower limit of the Operating Pressure Range. (See Figure 4.)

Offset – The output signal obtained when the Reference Pressure is applied to all available pressure ports. Also known as 'null' or 'zero'. (See Figure 4.)

Offset Error – The maximum deviation in measured Offset at Reference Temperature relative to the ideal (or target) Offset as determined from the Ideal Transfer Function. See also Thermal Effect on Offset.

Operating Pressure Range – The pressure range (or ranges) over which the product will produce an output proportional to pressure within the specified performance limits. (See Figure 4.)

Operating Temperature Range – The temperature range over which the product will produce an output proportional to pressure but may not remain within the specified performance limits.

Output Resolution – The smallest difference between output signal readings which can be meaningfully distinguished or resolved.

Overpressure – The Absolute Maximum Rating for pressure which may safely be applied to the product for it to remain in specification once pressure is returned to the Operating Pressure Range. Exposure to higher pressures may cause permanent damage to the product. Unless otherwise specified, this applies to all available pressure ports at any temperature within the Operating Temperature Range. Also known as 'Proof Pressure'.

Pressure Hysteresis – The maximum difference between output readings when the same pressure is applied consecutively, under the same operating conditions, with pressure approaching from opposite directions within the specified Operating Pressure Range.

Pressure Non-Linearity – The maximum deviation of product output from a straight line fitted to the output measured over the specified Operating Pressure Range. Standard methods of straight line fit specified for this calculation are either BFSL or TSL.

Span Error – The maximum deviation in measured Full Scale Span at Reference Temperature relative to the ideal (or target) Full Scale Span as determined from the Ideal Transfer Function. See also Thermal Effect on Span.

ISA100 Intrinsically Safe Wireless Pressure Sensor, IS-WPS Series

Thermal Effect on Offset – The maximum deviation in Offset due to changes in temperature over the Compensated Temperature Range, relative to Offset measured at Reference Temperature.

Thermal Effect on Span – The maximum deviation in Full Scale Span due to changes in temperature over the Compensated Temperature Range, relative to Full Scale Span measured at Reference Temperature.

Thermal Hysteresis – The maximum difference between output readings when the same temperature is reached consecutively, under the same operating conditions, with temperature approaching from opposite directions within the specified temperature range.

Total Error Band (TEB) – The maximum deviation in output from the Ideal Transfer Function over the entire Compensated Temperature and Pressure Range. Includes all errors due to: Offset, Full Scale Span, Pressure Non-Linearity, Pressure Hysteresis, Non-Repeatability, Thermal Effect on Offset, Thermal Effect on Span and Thermal Hysteresis. (See Figure 5.)

Working Pressure – The maximum pressure that may be applied to the product in continuous use. This pressure may be outside the Operating Pressure Range in which case the product may not provide a valid output until pressure is returned to within the Operating Pressure Range. Unless otherwise specified this applies to all available pressure ports at any temperature with the Operating Temperature Range. Note that the product may be operated continuously at pressures up to the Working Pressure, as compared with Overpressure which is an Absolute Maximum Rating.

Figure 5. Total Error Band Explanation
All Possible Errors

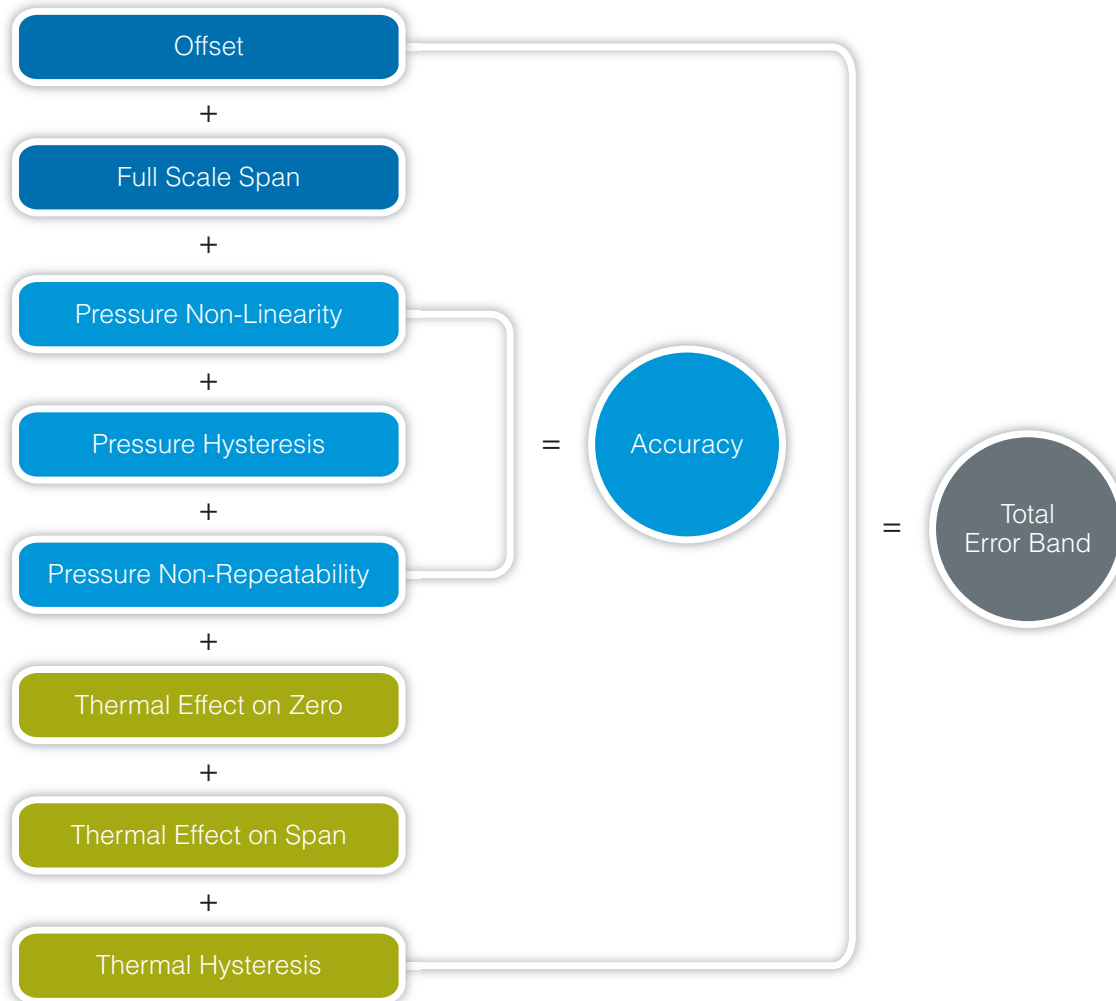

ISA100 Intrinsically Safe Wireless Pressure Sensor, IS-WPS Series

Third Party Software License

This product contains software provided by third parties, which may include the below listed components. The Honeywell product that includes this file does not necessarily use all of the third party software components referred to below.

Package(s) using BSD 3-clause (Texas Instruments) license

* Texas Instruments 802.15.4 MAC [Copyright © 2010 Texas Instruments Incorporated - <http://www.ti.com/>]

License Text [BSD 3-clause (Texas Instruments)]

Copyright © 2010 Texas Instruments Incorporated - <http://www.ti.com/>

Redistribution and use in source and binary forms, with or without modification, are permitted provided that the following conditions are met:

- 1) Redistributions of source code must retain the above copyright notice, this list of conditions and the following disclaimer.
- 2) Redistributions in binary form must reproduce the above copyright notice, this list of conditions and the following disclaimer in the documentation and/or other materials provided with the distribution.
- 3) Neither the name of Texas Instruments Incorporated nor the names of its contributors may be used to endorse or promote products derived from this software without specific prior written permission.

THIS SOFTWARE IS PROVIDED BY THE COPYRIGHT HOLDERS AND CONTRIBUTORS "AS IS" AND ANY EXPRESS OR IMPLIED WARRANTIES, INCLUDING, BUT NOT LIMITED TO, THE IMPLIED WARRANTIES OF MERCHANTABILITY AND FITNESS FOR A PARTICULAR PURPOSE ARE DISCLAIMED. IN NO EVENT SHALL THE COPYRIGHT OWNER OR CONTRIBUTORS BE LIABLE FOR ANY DIRECT, INDIRECT, INCIDENTAL, SPECIAL, EXEMPLARY, OR CONSEQUENTIAL DAMAGES (INCLUDING, BUT NOT LIMITED TO, PROCUREMENT OF SUBSTITUTE GOODS OR SERVICES; LOSS OF USE, DATA, OR PROFITS; OR BUSINESS INTERRUPTION) HOWEVER CAUSED AND ON ANY THEORY OF LIABILITY, WHETHER IN CONTRACT, STRICT LIABILITY, OR TORT (INCLUDING NEGLIGENCE OR OTHERWISE) ARISING IN ANY WAY OUT OF THE USE OF THIS SOFTWARE, EVEN IF ADVISED OF THE POSSIBILITY OF SUCH DAMAGE.

Package(s) using Analog Devices License

* AD7799 Communication Driver [Copyright 2012 ©Analog Devices, Inc.]

License Text (Analog Devices, Inc. License)

Copyright 2012 ©Analog Devices, Inc. All rights reserved. Redistribution and use in source and binary forms, with or without modification, are permitted provided that the following conditions are met:

- Redistributions of source code must retain the above copyright notice, this list of conditions and the following disclaimer.
- Redistributions in binary form must reproduce the above copyright notice, this list of conditions and the following disclaimer in the documentation and/or other materials provided with the distribution.
- Neither the name of Analog Devices, Inc. nor the names of its contributors may be used to endorse or promote products derived from this software without specific prior written permission.
- The use of this software may or may not infringe the patent rights of one or more patent holders. This license does not release you from the requirement that you obtain separate licenses from these patent holders to use this software.
- Use of the software either in source or binary form must be run on or directly connected to an Analog Devices Inc. component.

THIS SOFTWARE IS PROVIDED BY ANALOG DEVICES "AS IS" AND ANY EXPRESS OR IMPLIED WARRANTIES, INCLUDING, BUT NOT LIMITED TO, NON-INFRINGEMENT, MERCHANTABILITY AND FITNESS FOR A PARTICULAR PURPOSE ARE DISCLAIMED. IN NO EVENT SHALL ANALOG DEVICES BE LIABLE FOR ANY DIRECT, INDIRECT, INCIDENTAL, SPECIAL, EXEMPLARY, OR CONSEQUENTIAL DAMAGES (INCLUDING, BUT NOT LIMITED TO, INTELLECTUAL PROPERTY RIGHTS, PROCUREMENT OF SUBSTITUTE GOODS OR SERVICES; LOSS OF USE, DATA, OR PROFITS; OR BUSINESS INTERRUPTION) HOWEVER CAUSED AND ON ANY THEORY OF LIABILITY, WHETHER IN CONTRACT, STRICT LIABILITY, OR TORT (INCLUDING NEGLIGENCE OR OTHERWISE) ARISING IN ANY WAY OUT OF THE USE OF THIS SOFTWARE, EVEN IF ADVISED OF THE POSSIBILITY OF SUCH DAMAGE.

ADDITIONAL MATERIALS

The following associated literature is available on the Honeywell web site at sensing.honeywell.com:

- Installation and technical manual
- Installation instructions
- Limitless™ product range guide
- Application note

WARNING **PERSONAL INJURY**

DO NOT USE these products as safety or emergency stop devices or in any other application where failure of the product could result in personal injury.

Failure to comply with these instructions could result in death or serious injury.

WARNING **MISUSE OF DOCUMENTATION**

- The information presented in this product sheet is for reference only. Do not use this document as a product installation guide.
- Complete installation, operation, and maintenance information is provided in the instructions supplied with each product.

Failure to comply with these instructions could result in death or serious injury.

Warranty/Remedy

Honeywell warrants goods of its manufacture as being free of defective materials and faulty workmanship. Honeywell's standard product warranty applies unless agreed to otherwise by Honeywell in writing; please refer to your order acknowledgement or consult your local sales office for specific warranty details. If warranted goods are returned to Honeywell during the period of coverage, Honeywell will repair or replace, at its option, without charge those items that Honeywell, in its sole discretion, finds defective. **The foregoing is buyer's sole remedy and is in lieu of all other warranties, expressed or implied, including those of merchantability and fitness for a particular purpose. In no event shall Honeywell be liable for consequential, special, or indirect damages.**

While Honeywell may provide application assistance personally, through our literature and the Honeywell web site, it is customer's sole responsibility to determine the suitability of the product in the application.

Specifications may change without notice. The information we supply is believed to be accurate and reliable as of this printing. However, Honeywell assumes no responsibility for its use.

Find out more

Honeywell serves its customers through a worldwide network of sales offices, representatives and distributors. For application assistance, current specifications, pricing or name of the nearest Authorized Distributor, contact your local sales office.

To learn more about Honeywell's sensing and control products, call **+1-815-235-6847** or **1-800-537-6945**, visit **sensing.honeywell.com**, or e-mail inquiries to **info.sc@honeywell.com**

Honeywell Safety and Productivity Solutions

9680 Old Bailes Road
Fort Mill, SC 29707
honeywell.com

32317842-1-EN IL50 GLO
August 2016
© 2016 Honeywell International Inc. All rights reserved.
Hastelloy® is the registered trademark name of Haynes International, Inc

Honeywell